

Single Screw Feeders

Einwellige Austragschnecken

Extracteurs simples

Estrattori semplici

SU

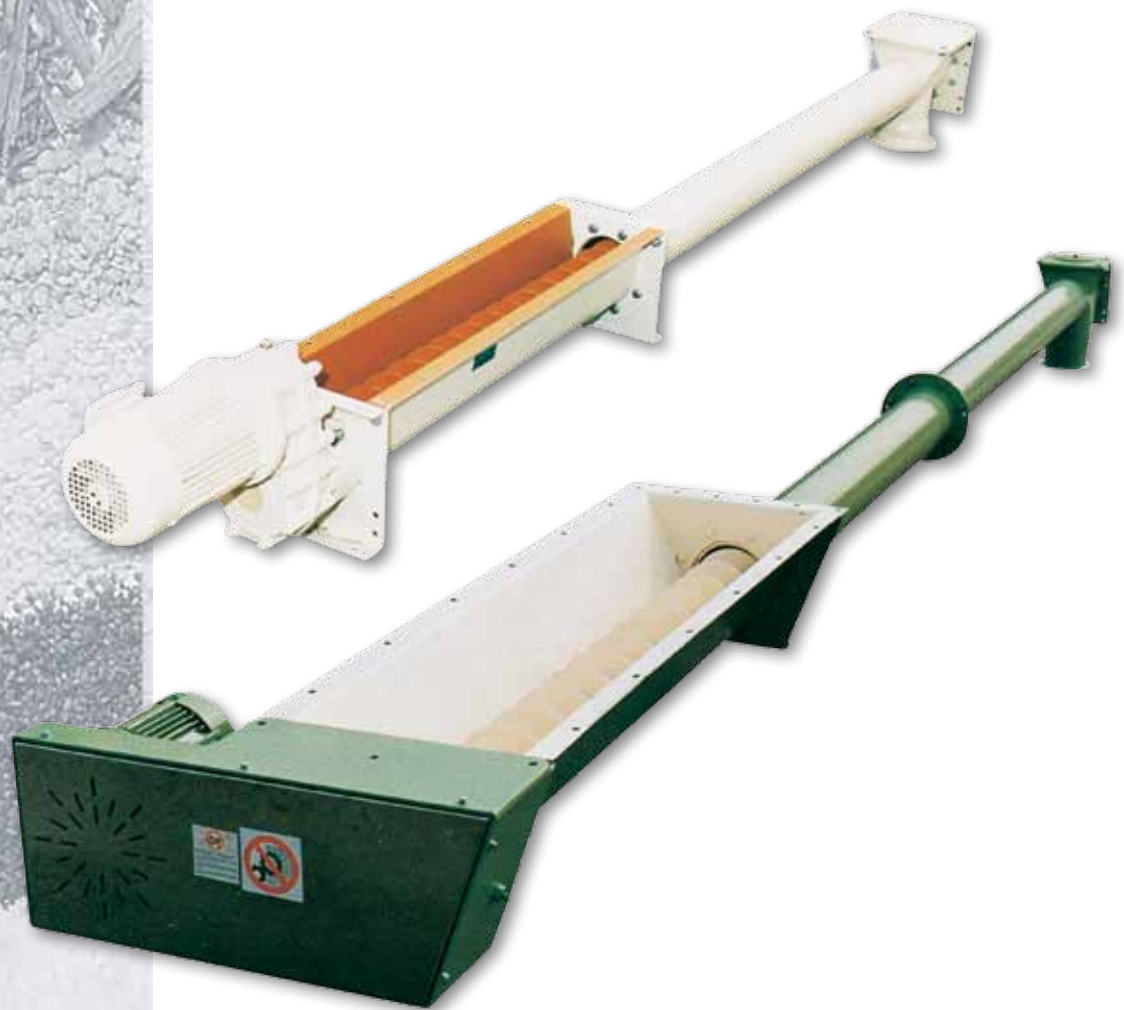



MECHANICAL PARTS: End bearing assemblies complete with bearings, seals, grease nipples and dust-proof packing glands. Intermediate bearings with self-lubricating bushes.

MECHANIK: Endlager mit Wälzlagern, Wellendichtringen, Schmiernippeln und Stopfbuchsen. Zwischenlager mit selbstschmierenden Buchsen

MÉCANIQUE: Paliers d'extrémité dotés de roulements, de joints d'étanchéité, de graisseurs et de groupes d'étanchéité à la poussière à presse-étoupe. Paliers intermédiaires dotés de douilles en matériau autolubrifiant.

MECCANICA: Supporti d'estremità completi di cuscinetti, anelli di tenuta, ingrassatori e gruppi tenuta polvere a premistoppa - Supporti intermedi con boccole in materiale autolubrificante.

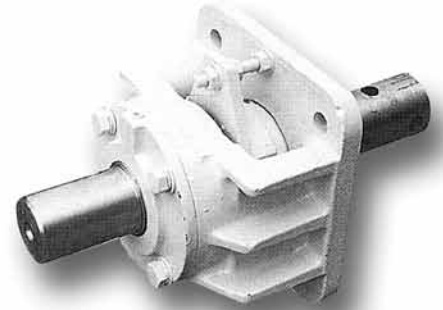
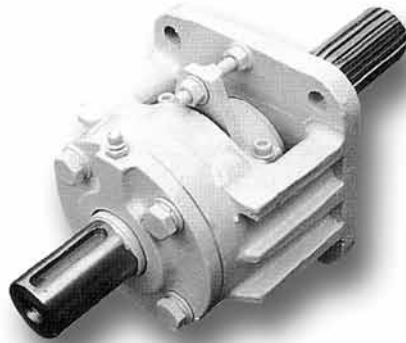

OUTLETS: Cylindrical type fitted with drilled flange (in accordance to WAM standard).

AUSLÄUFE: in zylindrischer Ausführung mit gebohrten Flanschen (nach WAM-Norm).

BOUCHES: Bouches de décharge de type cylindrique dotées de brides percées (selon standard WAM).

BOCCE: Bocche di scarico cilindrica con flange forate (secondo standard WAM).



DRIVES HEADS: with incorporated end bearing assembly directly connected to the screw.

ANTRIEBSEINHEITEN: Getriebemotor mit integriertem Lager direkt mit der Schneckenwelle verbunden.

MOTORÉDUCTEURS: directement accouplé à l'auge.

TESTATE MOTRICI: Motoriduttore direttamente accoppiato alla coclea.



OPTIONS: Food-grade paint finish - Drive unit with coupling, chain or belt transmission -

Manual gates - Square, rectangular or tapered outlet spouts, fitted with drilled flange (WAM std.).

SONDERAUSSTATTUNG: Sonderanstriche für Lebensmittel - Antriebe über Kette oder Riemen - quadratische, rechteckige oder kegelstumpfförmige Ausläufe.

ÉQUIPEMENT SUPPLÉMENTAIRE: Peinture pour alimentaire - Motorisation avec entraînement par chaîne ou par

poulies et courroies - Vanne à guillotine manuelle - Bouche de décharge de type carrée, rectangulaire ou de type à cône inversé dotée de bride percée (std WAM).

A RICHIESTA: Verniciature per alimentari - Motorizzazioni con trasmissione a catena o a pulegge - Serrande manuali -

Bocche di scarico di tipo quadrato, rettangolare o a cono inverso con flange forate (std WAM).



- Direct drive
- Direktantrieb
- Motorisation directe
- Motorizzazione diretta



- Drive unit with belt transmission
- Antrieb mit Keilriemenübersetzung
- Motorisation avec entraînement par poulies et courroies
- Motorizzazione con trasmissione a pulegge

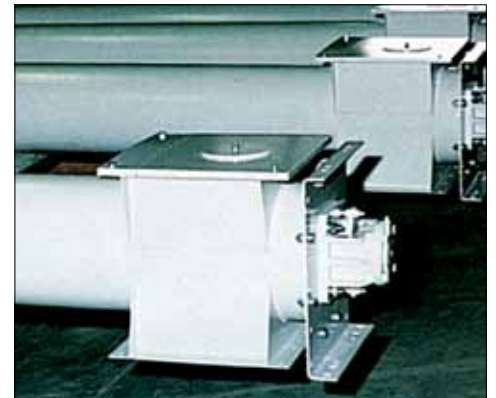

- Square outlet spouts
- Quadratische Ausläufe
- Bouches de décharge de type carré
- Bocche di scarico di tipo quadrato



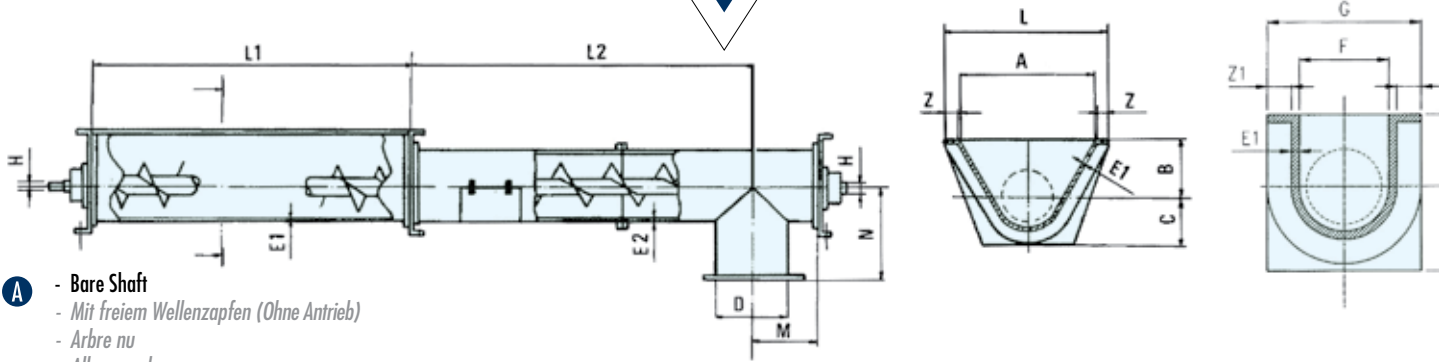

- A** - Bare Shaft
 - Mit freiem Wellenzapfen (Ohne Antrieb)
 - Arbre nu
 - Albero nudo

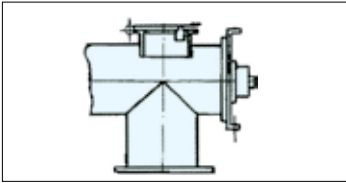

- Overflow Hatch Flap**
 - Überlaufklappe
 - Capot anti-bourrage
 - Portello antintasamento

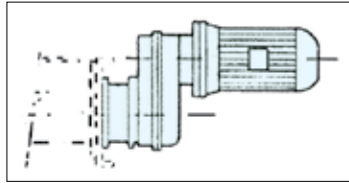

- B** - Direct Drive
 - Direktantrieb
 - Entraînement direct
 - Trasmissione diretta

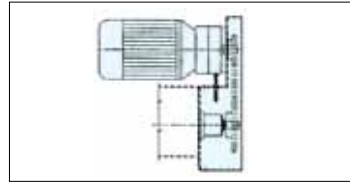

- D** - Chain Transmission
 - Antrieb mit Kettenübersetzung
 - Entraînement par chaîne
 - Trasmissione a catena

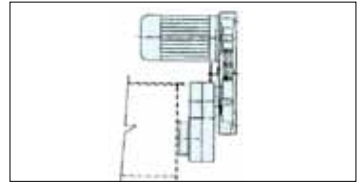

- E** - Pulley Drive
 - Antrieb mit Keilriemenübersetzung
 - Entraînement par poulies et courroies
 - Trasmissione a pulegge

Trough screw conveyors and feeders are manufactured to the customer's requirements by means of standard components available from stock, thus enabling quick delivery.

Die Trogförder- und Trogaustragschnecken werden kommissionsgebunden aus Baukasten-elementen aus dem Lagerbestand angefertigt; auf diese Weise sind sehr kurze Lieferzeiten möglich.

Sur demande, exécution de vis sans fin de transport avec des éléments modulaires standard (déjà en stock). Délais très courts.

Le coclee estraiatrici sono prodotte a richiesta mediante elementi modulari standard a stock, con tempi di consegna brevissimi.

Screw Wendel Spire Spira Ø	Trough Trog Auge Truogolo U-V		Tubular trough Rohrtrog Auge tubulaire Truogolo tondo O			A	B	C	D	F	G	H	L	M	N*	Q	Z	Z1
	L1	E1	Ø	E2	L2													
100	500 750 1000	2	114	3	VAR.	175	115	145	114	-	-	25	265	120	120	-	40	-
120	500 750 1000	2	139	3	VAR.	175	115	145	168	-	-	25	265	120	210	-	40	-
150	500 750 1000 1250	2	168	4	VAR.	375	175	145	168	175	265	35	485	140	175	115	50	40
200	500 750 1000 1250	2	219	4	VAR.	425	200	185	219	225	315	35	540	160	205	135	50	40
250	500 750 1000 1250	2	273	4	VAR.	525	225	215	273	275	365	35	655	180	250	160	60	40
300	500 1000 1250 1500	3	323	4	VAR.	525	250	245	323	325	435	55	655	220	300	195	60	50
350	1000 1250 1500	3	406	5	VAR.	625	270	275	406	375	485	55	755	280	360	235	60	50
400	1000 1250 1500	3	457	5	VAR.	730	290	305	457	425	540	55	900	320	420	270	80	50

Dimensions mm

* For cylindrical outlet (in compliance with WAM® standard)

Für Ausläufe in zylindrischer Ausführung (nach WAM® - Norm)

Pour bouches de décharge cylindrique (selon standard WAM®) - Per bocche cilindrica (secondo standard WAM®)

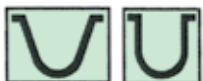

FABRICATED PARTS: Carbon steel troughs
 STAHLBAU: Tröge aus Normalstahl
 CHARPENTE: Auges en acier normal
 CARPENTERIA: Truogoli in acciaio normale



FLIGHTS: Carbon steel helicoid flights with differing pitch welded on the centre pipe.
 SCHNECKENWENDELN: aus Normalstahl mit differenzierter Steigung, auf Innenrohr geschweißt.
 SPIRES: Spires en acier, à pas différents, soudées sur le tube interne.
 SPIRE: Spire in acciaio a passi differenziati saldate al tubo interno.



Further Products - Outra produção - Otros Productos - Altra produzione



UNI EN ISO 9001
Certified Company

www.wamgroup.com